

Front view

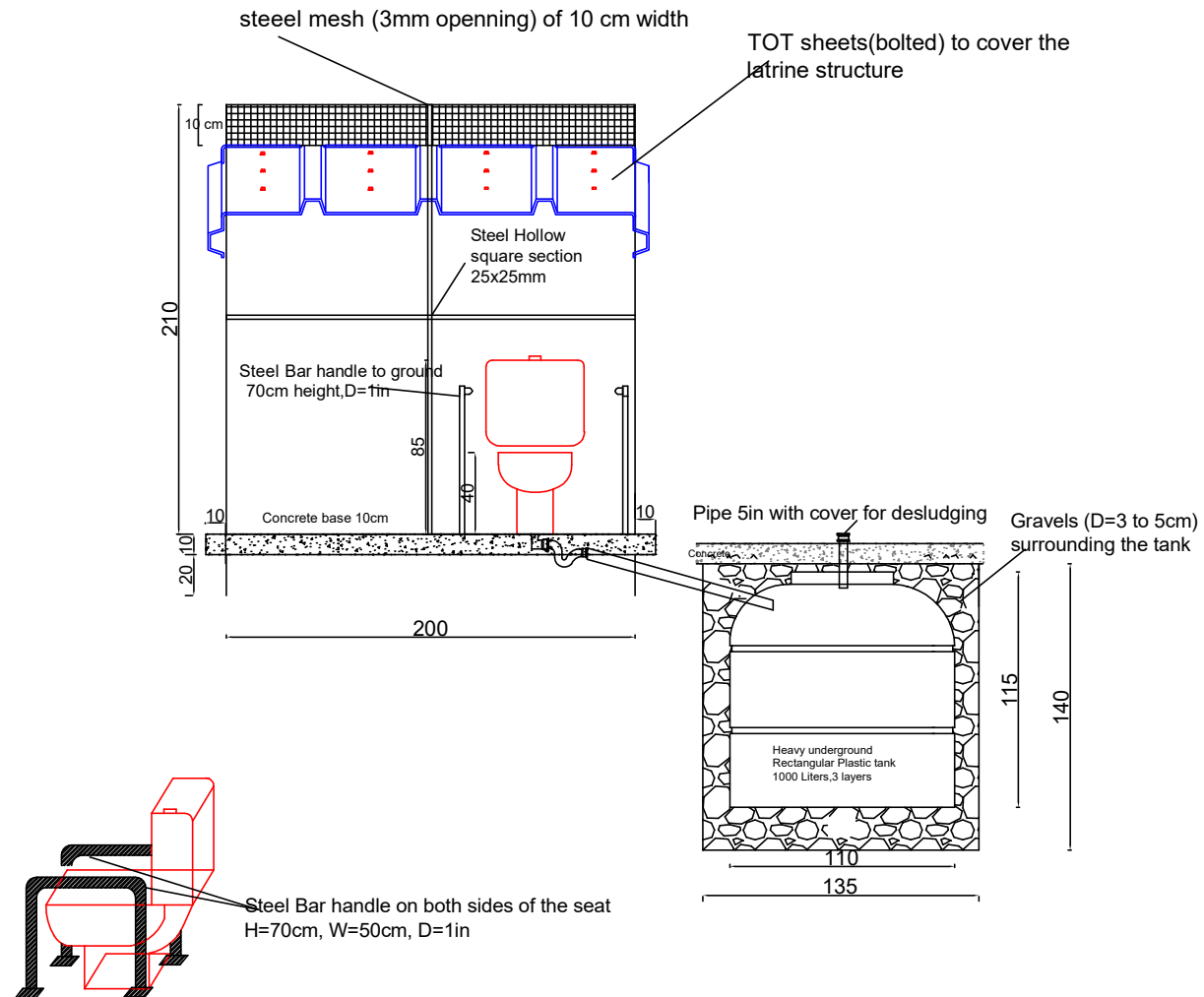

Humanitarian Response and Assistance for People Affected by the Syrian Crisis

All units are in centimeters /not to scale

WASH Team

Special Needs Latrine Dwg

Annex 1

Side view

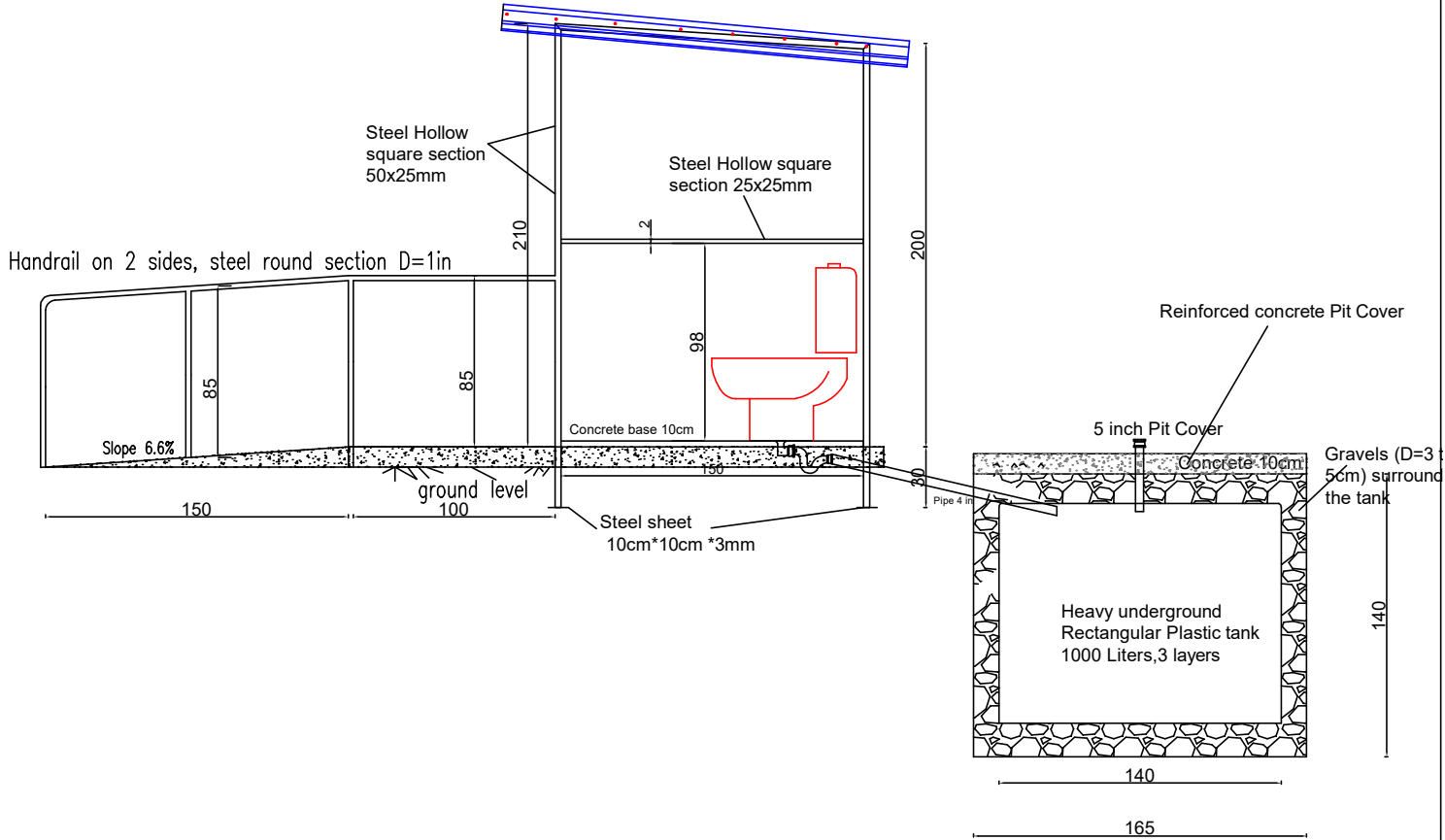

Humanitarian Response and Assistance for People Affected by the Syrian Crisis

All units are in centimeters /not to scale

WASH Team

Special Needs Latrine Dwg

Annex 2

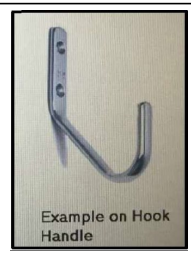
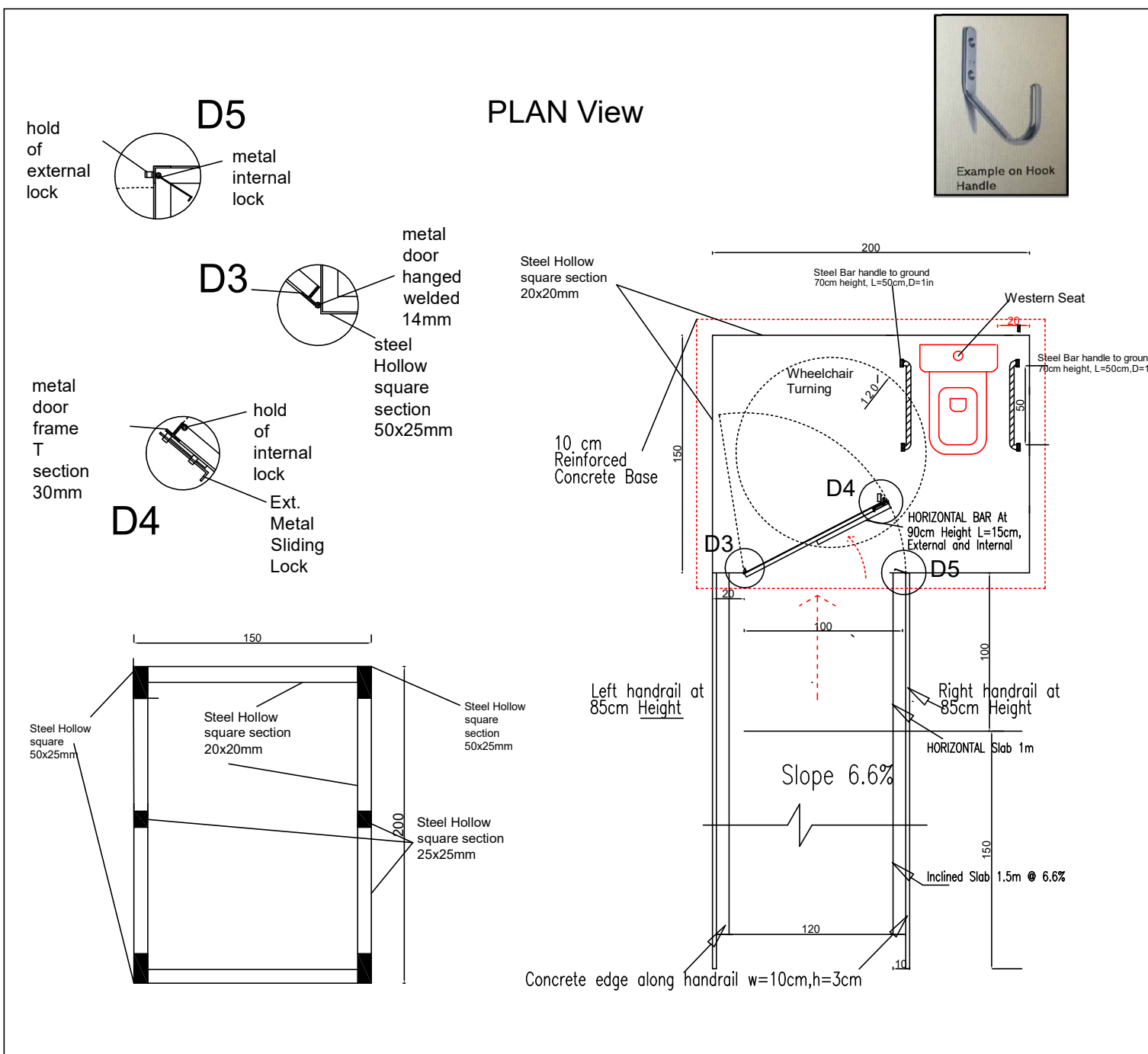

PLAN View

Concrete cover for the pit

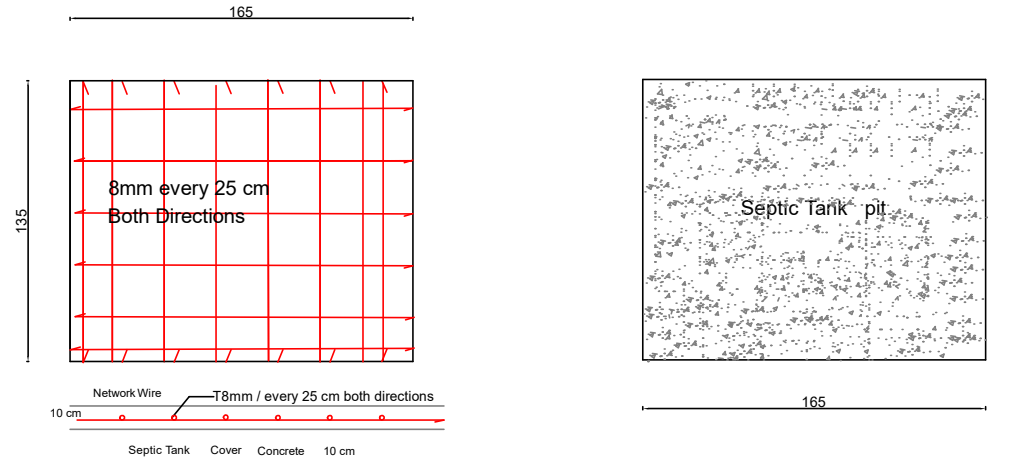

Concrete Base for the latrine

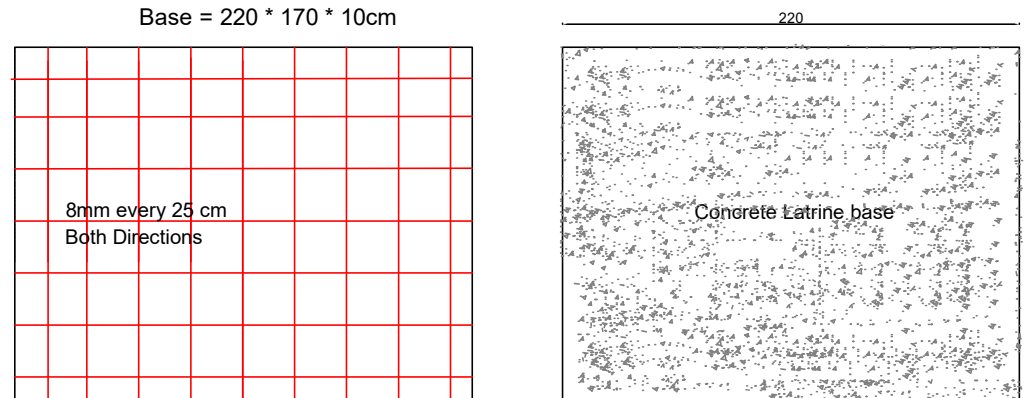

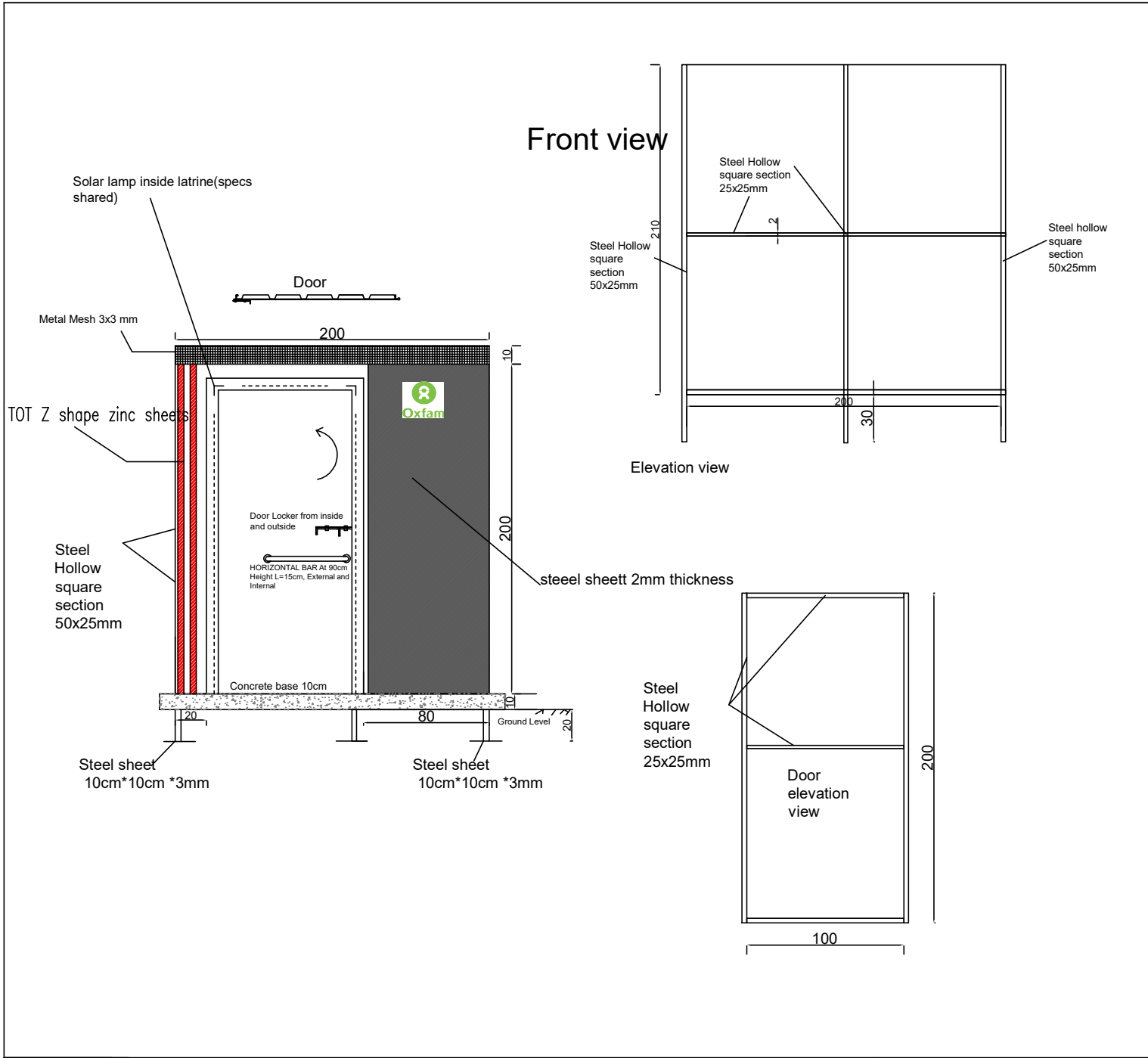

Steel stand with water tank

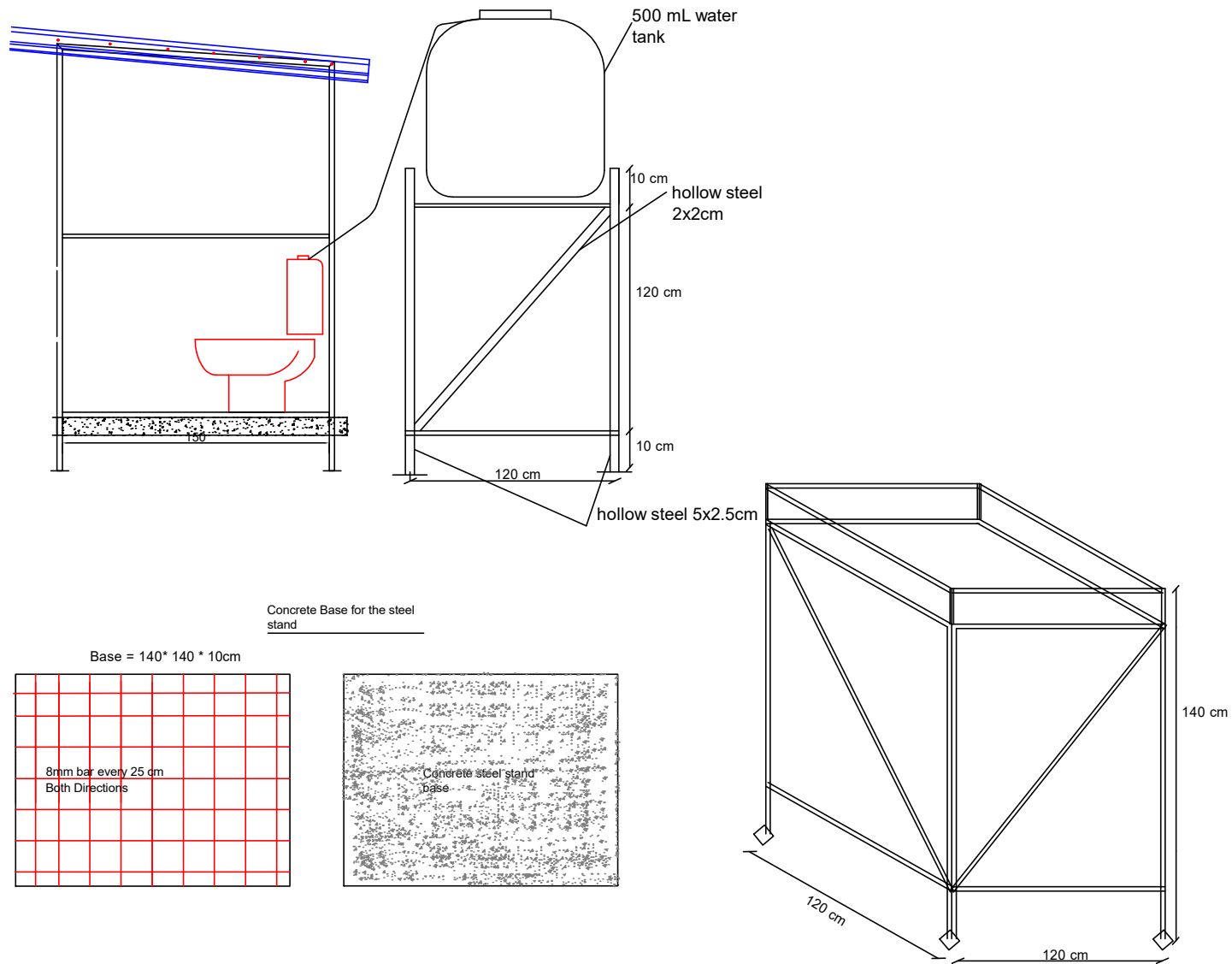

Wash basin with Soak pit

